

SW200DC Swing Gate Opener User Manual

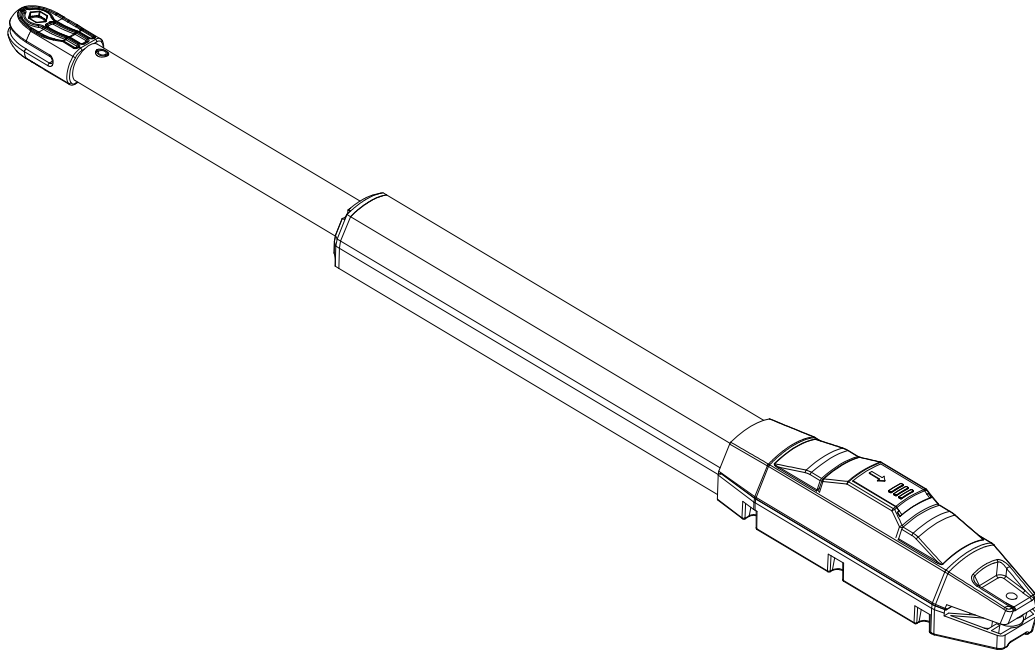

Dear users,

Thank you for choosing this product. Please read the manual carefully before assembling and using it.







Please do not leave out the manual if you send this product to a third party.

1. Safety Instruction

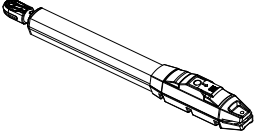
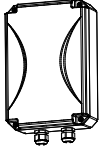

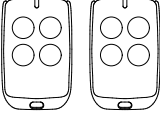
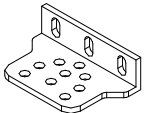
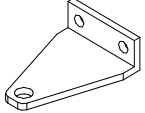
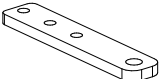

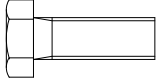
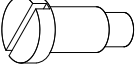
- Please read this manual carefully before installation, in which involves with important information about installation、using、maintenance and safety.
- Any undefined operations under this manual is not allowed, incorrect using may damage the product even causing the injuries or property losses.
- To consider the possible danger during the installation or using process of swing gate operator, installation must strictly comply with the construction standard and electrical operating procedure.
- Before installation, please make sure that the power voltage being used matches with the supply voltage of this product. Please check if the leakage protection switch is installed and the grounding system is correct.
- Please check if additional equipment or materials are required to meet the specific requirements.
- The disposal of packaging material must be complying with the local regulation.
- Please do not change any parts except for those defined under this manual. Any undefined changes may cause the malfunction. Any damages to the product arising therefrom shall be beyond the liability of the company.
- Please do not leak water or any liquid into the controller or any other open devices. Please disconnect the power immediately if any mentioned cases happened.
- Please keep this product away from heat and open fire. Or it may damage the components; cause the failure or other hazards.
- Please make sure there is no vehicles、passengers and objects passing through while the swing gate is moving.
- Anti-clip equipment like infrared protection switch must be installed to avoid injuries to person and property losses. The company shall not be liable for any damage or accident arising therefrom.
- The installation、using and maintenance of this product must be carried out by professionals.
- Children are not allowed be touch the control devices or remote transmitters.
- A warning sign must be placed somewhere on the swing gate according to the national standard.
- Please keep this instruction properly for future reference.

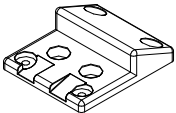
2. Packing List (Standard)

No.	Picture	Name	Quantity
1		Main machine	2
2		Control box	1
3		Manual release key	2
4		Remote control	2
5		Wall bracket	4
6		Front mounting bracket	2
7		Connecting bracket	2
8		Cotter pins	2
9		T-shaped cylindrical pin with hole	2
10		Screw M8X25	4
11		Mounting screw (short)	2
12		Self-locking Nut M8	6
13		Limit stopper	1

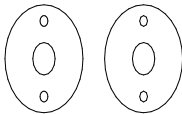
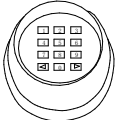
Packing List (Optional)

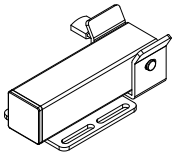
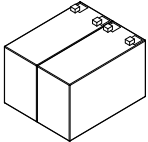
No.	Picture	Name	Quantity
1		Infrared sensor	1
2		Wireless keypad	1
3		Alarm lamp	1
4		Electric lock	1
5		Storage battery	2

Due to the difference of installation environment, our company does not provide the installation accessories to fix and connect gate openers and wall. Please prepare the these installation accessories according to actual site situation.

3. Technical Parameters

Model	SW200DC
Power supply	220V/50Hz;110V/60Hz
Motor power	30W
Gate moving speed	18~22s/ 90°
Max.single-leaf weight	200kg
Max.single-leaf length	2M
Max.force	2200N
Max.piston stroke	32cm
Remote control distance	30m
Remote control mode	Single/Four button mode
Storage battery (optional)	DC24V(4.5Ah or 9Ah)
Noise	≤58dB
Recording of up remote controls	32pcs
Remote frequency	433.92 MHz
Working temperature	-20°C - +70°C
Package weight	10kg

4. Installation Drawing

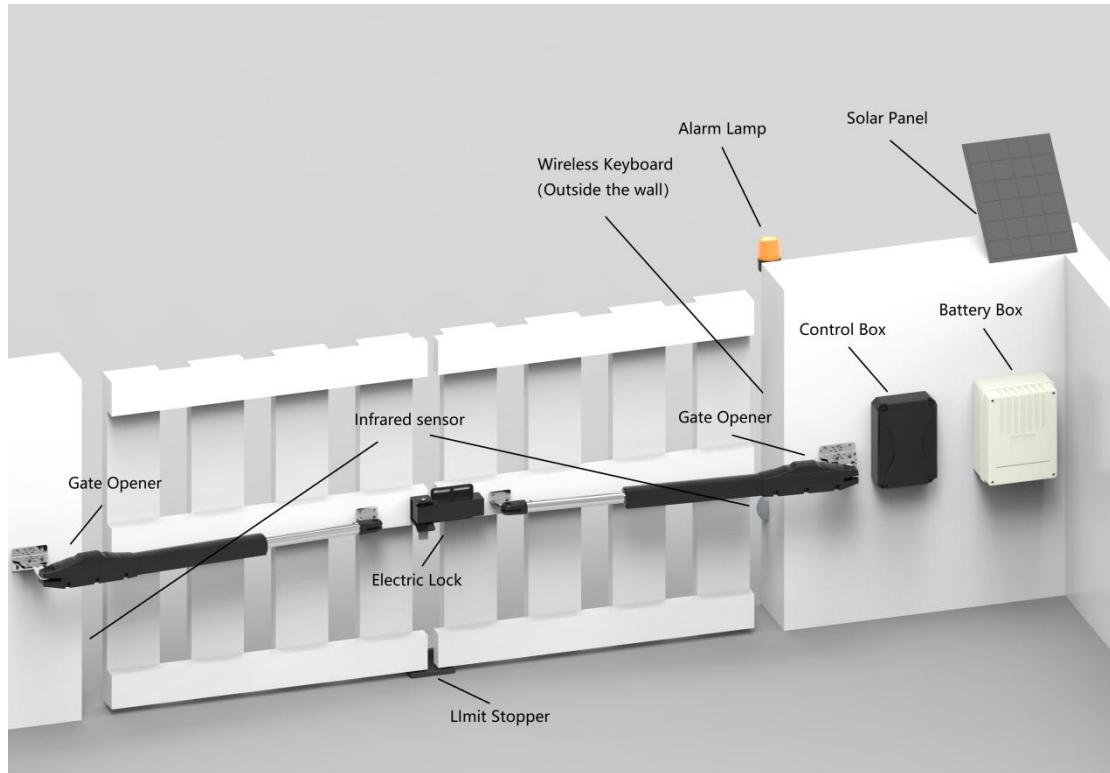
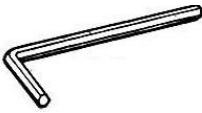
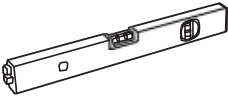

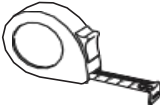





Figure 1

SW200DC swing gate opener is applicable to single leaf gate weight less than 200kg, and the length shorter than 2m. The drive mode adopts planetary transmission to combine with the screw rod transmission. This gate opener must be installed inside the enclosure or yard for protection.

5. Tools Needed for Standard Installation

	No.6 Allen Wrench		Spirit Level
	Slotted Screwdriver		Tape
	Phillips Screwdriver		Adjustable Wrench X 2
	Hatching Pen		

 **Note: the cables must be suitable for outdoor use.**

6. Cable List

	Cable Application	Cable Material	Max. Length
1	Cable of 220V controlbox's power supply	3×2.5mm ² (>30m) 3×1.5mm ² (<30m)	Unlimited
2	Cable of gate opener's power supply	2×1.5mm ²	15m
3	Cable of infrared sensor	2×0.5mm ²	10m
4	Cable of alarm lamp	2×0.5mm ²	10m
5	Cable of electric lock	2×0.5mm ²	10m
6	Extension cable of storage battery	2×1.5mm ²	10m
7	Cable of solar power	2×1.5mm ²	10m

Due to different installation environments, installer need to prepare power cables for control box and for gate openers.



Note: cable outlet should be downward to prevent rainwater from entering wire along the cable.

7. Direction of Gate Opening

7.1 Gate Opens Inwards

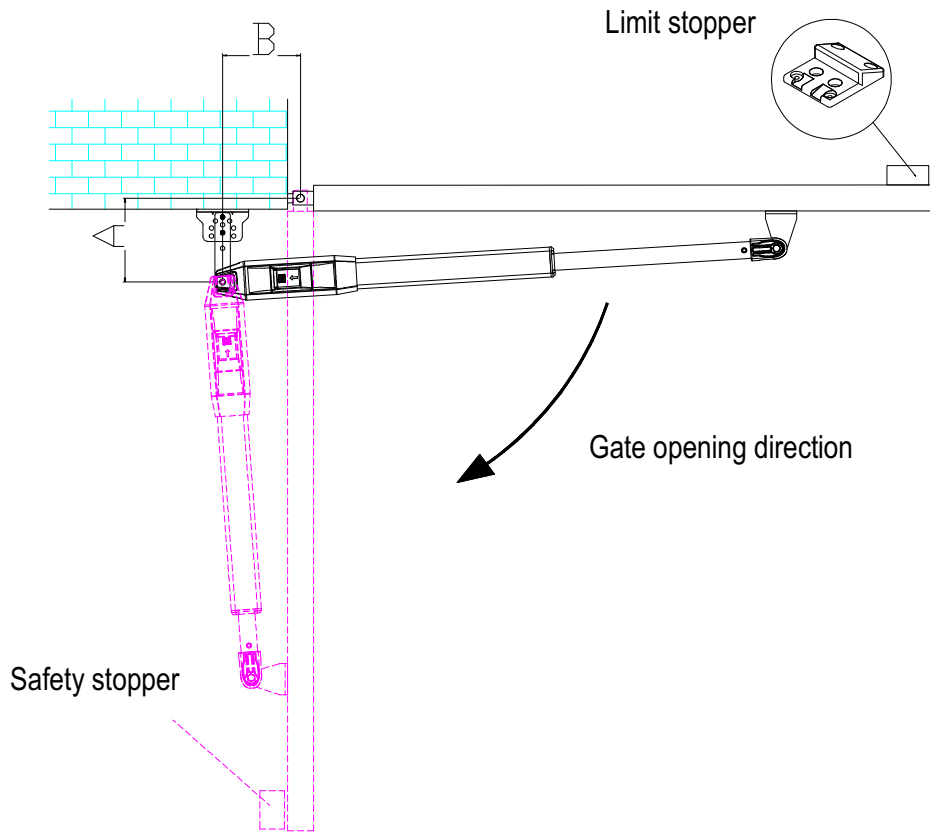

Figure 2

Recommended Installation Size:

A \ B	100mm	120 mm	140 mm	160 mm	180 mm	200 mm
100mm	103°	111.5°	118.5°	120.5°	108°	100.5°
120mm	101°	108.5°	115°	110°	100.5°	94.5°
140mm	99.5°	106.5°	112.5°	101°	94°	
160mm	98.5°	104.5°	101.5°	93°		
180mm	97.5°	103°	92°			
200mm	97°	90.5°				

Note: If the interval between the gate and the wall is too small or it has interference after the gate completely open, please install a gate safety stopper(prepare by user) to prevent injury to person or damage to property.

7.2 Gate Opens Outwards

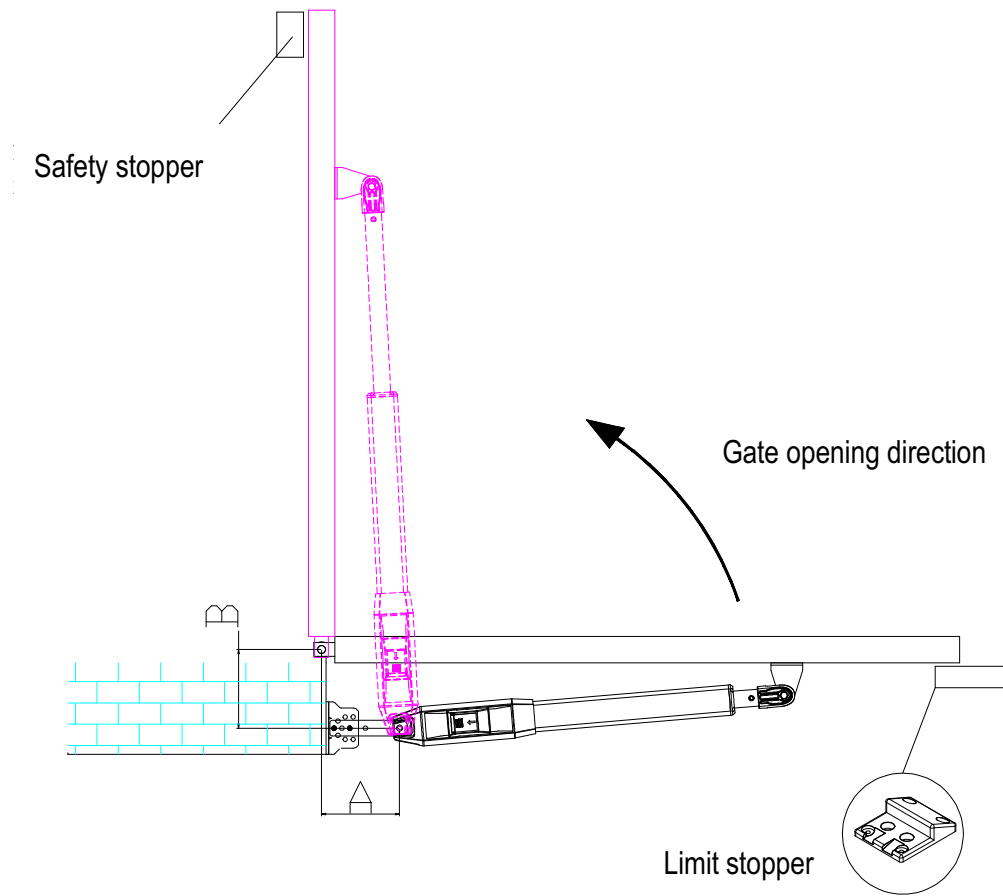

Figure 3

Recommended Installation Size:

A \ B	100mm	120 mm	140 mm	160 mm	180 mm	200 mm
100mm	103°	101°	99.5°	98.5°	97.5°	97°
120mm	111.5°	108.5°	106.5°	105°	103°	100.5°
140mm	118.5°	115°	112.5°	106°	96.5°	
160mm	121°	110°	101.5°	93.5°		
180mm	106°	98.5°	92°			
200mm	96.5°	90.5°				

Note: If the interval between the gate and the wall is too small or it has interference after the gate completely open, please install a gate safety stopper(prepare by user) to prevent injury to person or damage to property.

If there is enough space between the gate and the wall after the gate completely open, then safety stopper is not a must option. (Motor will stop after it's blocked)

8. Installation Steps

8.1 Preparation Before Main Machine Installation

- a) Before installing the gate opener, please confirm that the gates were installed correctly, ensure that the gate can be manually operated smoothly, and the limit stopper can effectively prevent the gate to continue moving.
- b) Please keep a distance of 15-20mm between the two swings for installing the electric lock. If electric lock is not required, then no need to consider the distance between the two swings;
- c) The recommended mounting height of the 2 main machines is around 300 ~ 800mm above the ground, and make sure there are reliable fixed points for mounting brackets.

Cable Bury

In order to ensure the normal operation of the gate opener and protect the cable from damage, please use two PVC pipes to bury the motor and power cables, and the control cables separately. One PVC pipe for motor and power cables, the other one for control cables.

Mounting Brackets Fixing

In order to install the SW200DC main machines firmly, it is recommended to use the expansion screws to fix the mounting brackets.

8.2 Accessory Installation

- A) Before installing the main machines, please install the wall bracket on the wall first, then fix the connecting bracket, finally install the front mounting bracket on the gate.

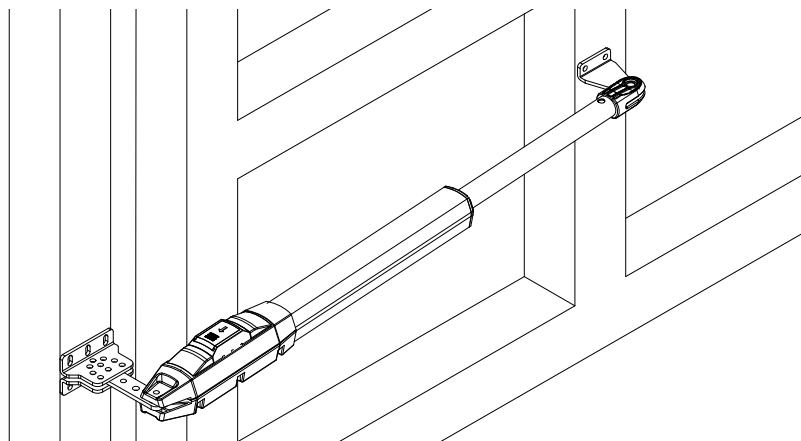

Figure 4

Note: Please measure by gradienter before fixing to ensure that the front mounting bracket and the connecting bracket are in the same level.

Connect the connecting bracket and two wall brackets, please refer to Figure 5.

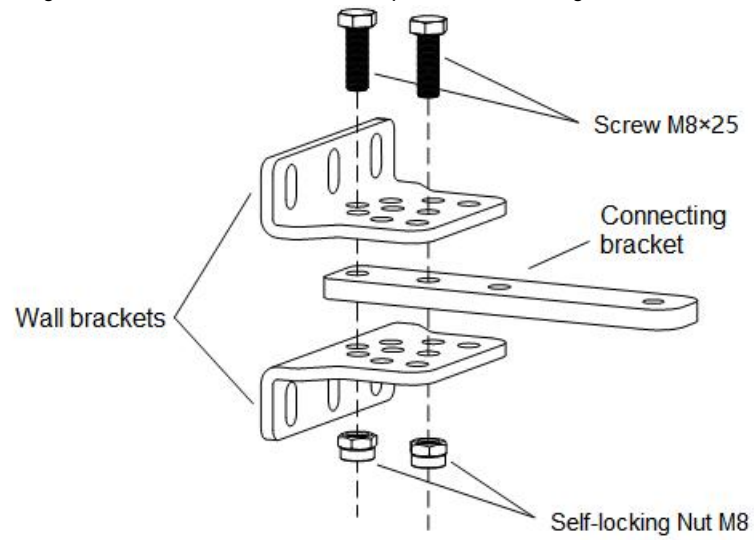

Figure 5

B) The connecting bracket and the wall bracket can be connected according to different conditions, please refer to figure 6.

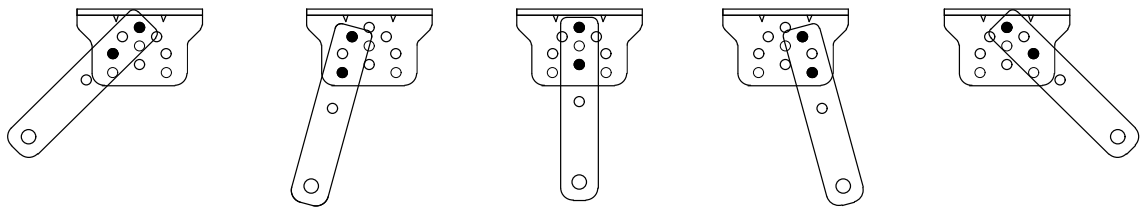

Figure 6

C) Before the installation, please unlock the two main machines. Unlock method: Open the manual release cover, insert the manual release key, rotate the key until it's released, as shown in Figure 7, then turn the telescopic arm, you'll find it's stretched by hand easily.

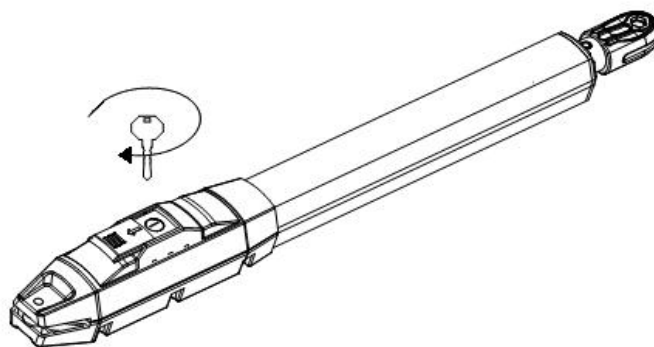

Figure 7

D) Connect the main machine with connecting brackets by screw and nut as shown in Figure 8.

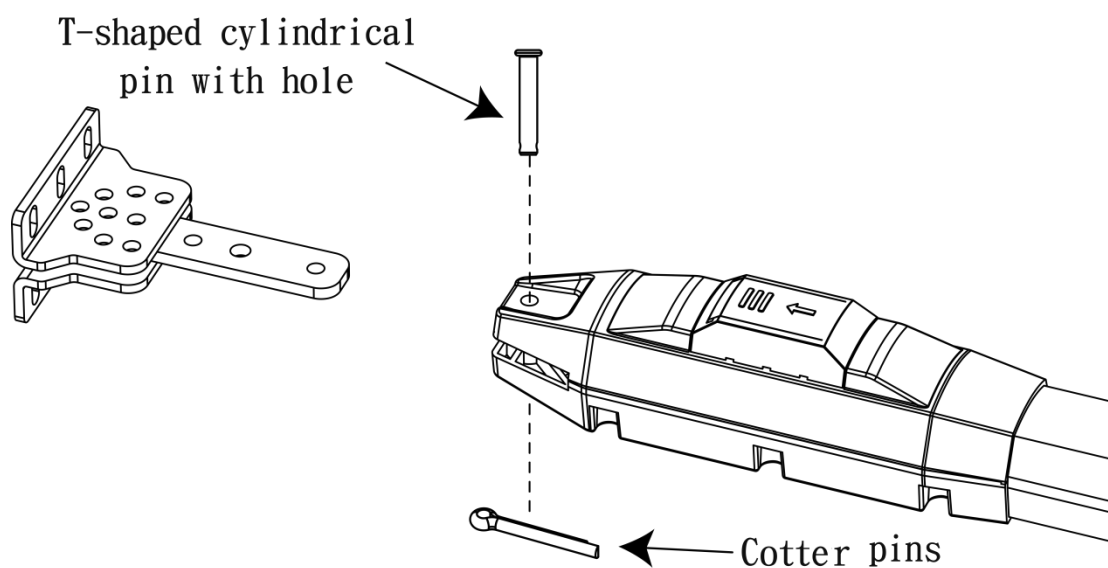

Figure 8

E) As shown in figure 9 below, connect wall bracket with wall according to marked position. Then, connect main machine with wall bracket by screw and nut. (Please use spirit level to make sure the installation levelness.)

Mouting screw(short)

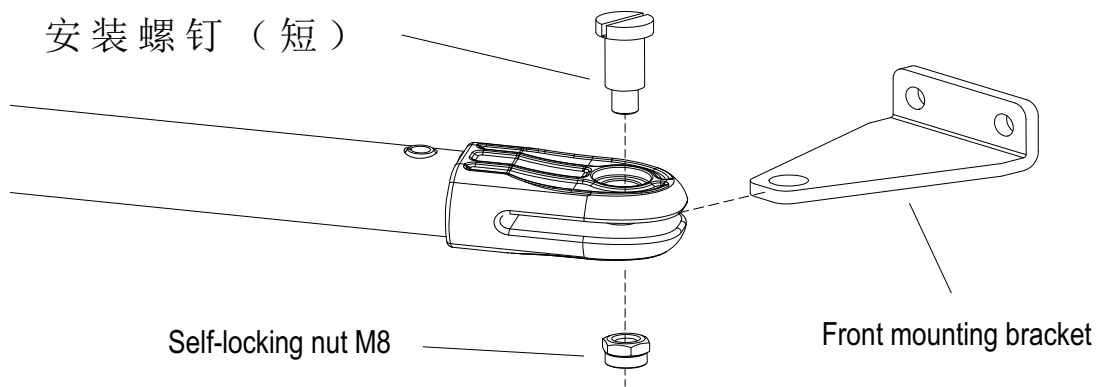

Figure 9

8.3 Dimension of Control Box

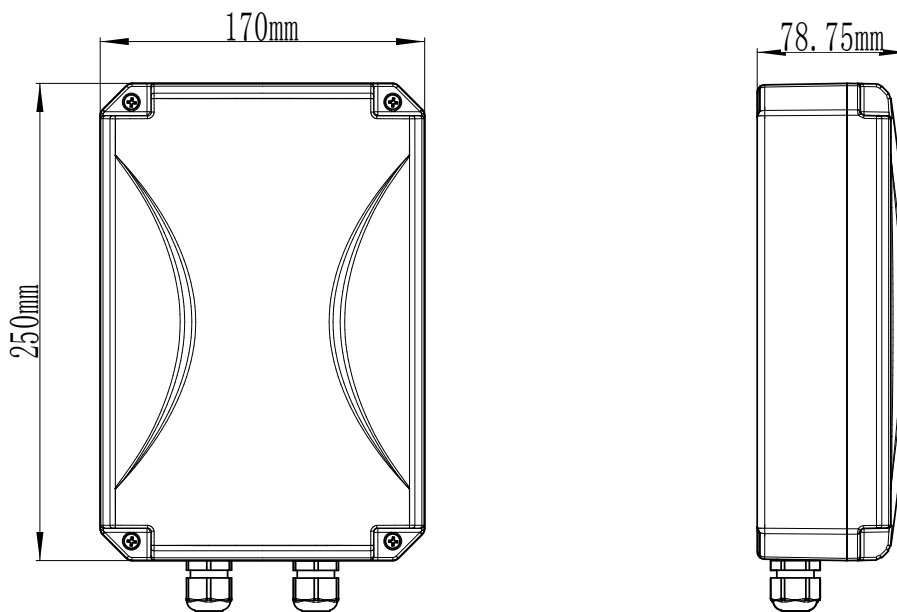

Figure 10



Note

- To ensure safety and protect the machines, please install a gate stopper at the open limit position when the gate opens outward to prevent the gate from running over its travel. Meanwhile, to enable the 2 swings to close to its accurate limit position, please install a limit stopper at the closed limit position (as shown in figure 3). Similarly, when the gate opens inward, please install a limit stopper at the closed limit position (as shown in figure 2).

- Before installing the main machine, please make sure the main machine and components are in good mechanical performance and the gate can be manually operated flexibly.
- One control unit can optionally drive one main machine or two main machines.
- Earth leakage circuit breaker must be installed on where the gate movement can be seen, and the minimum mounting height for the control box should be over 1.5m to avoid being touched by kids.
- After installation, please check whether the mechanical property is good or not, whether gate movement is flexible or not after unlocking, and whether the infrared sensor (optional) is installed correctly and effectively.

9. Wiring and Debugging

9.1 Wiring Instructions

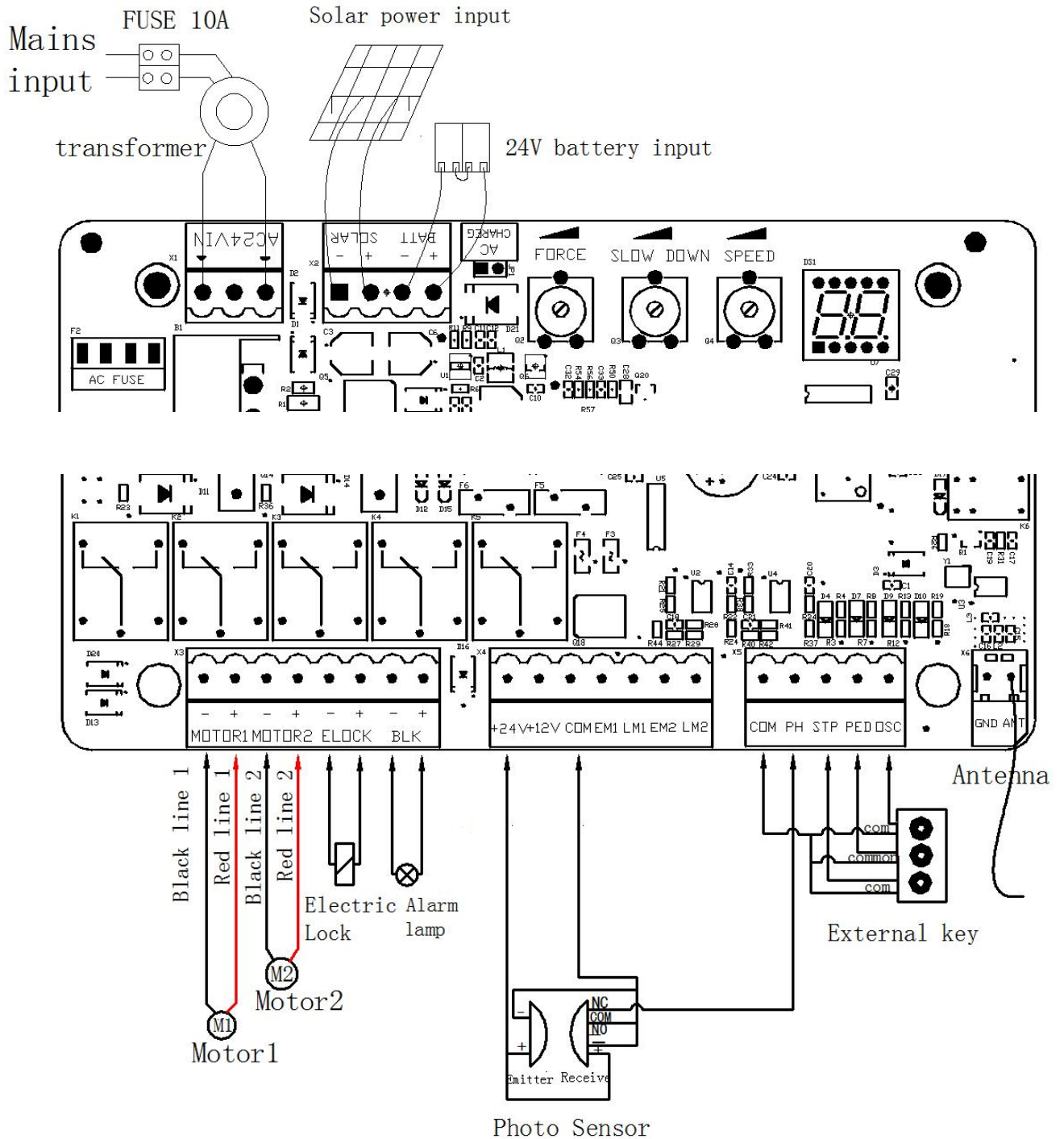

Figure 11

9.2 Control Board Drawing and Instructions

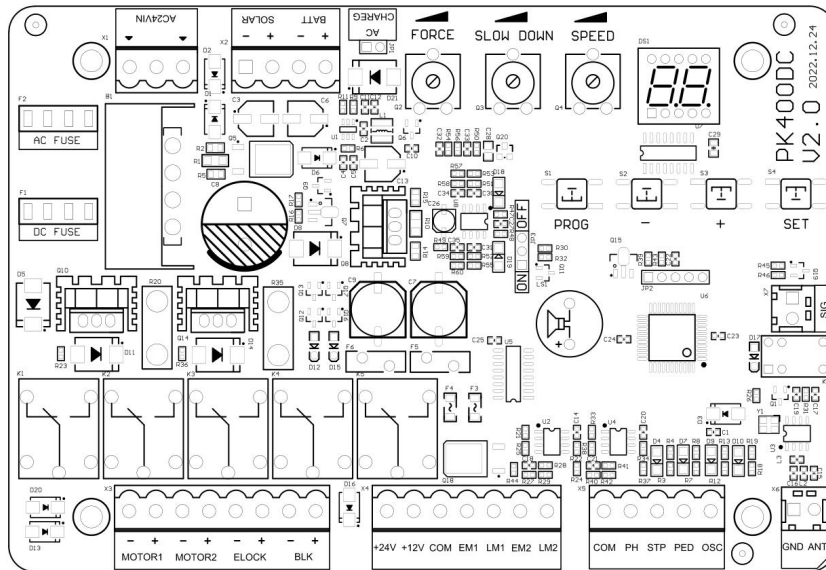

Figure 12

Terminal	Description
1. AC24VIN	24VAC Power Supply Input
2. +SOLAR-	Solar Power Input
3. +BATT-	24V Battery Input
4. FORCE	Resistance Force
5. SLOW DOWN	Slow Stop Distance
6. SPEED	Moving Speed
7. MOTOR1	Motor1 Output
8. MOTOR2	Motor2 Output
9. -ELOCK+	Electric Lock Output
10. -BLK+	Alarm Lamp Output (Note: pay attention to the negative and positive.)
11. +24V	24V Output Positive
12. +12V	12V Output Positive (No output under dormant state)
13. EM1	Motor1 Hall Sensor Power Output
14. LM1	Motor1 Hall Sensor Limit Signal Input
15. EM2	Motor2 Hall Sensor Power Output
16. LM2	Motor2 Hall Sensor Limit Signal Input
17. PH	Photo Sensor Input Active
18. PED	Single Gate/Pedestrian Mode Input Active
19. OSC	Single Channel Input Active
20. ANT	Antenna
21. COM	Common
22. SIG	The signal is normally closed only after the door is in place

Photo Sensor Wiring Instructions

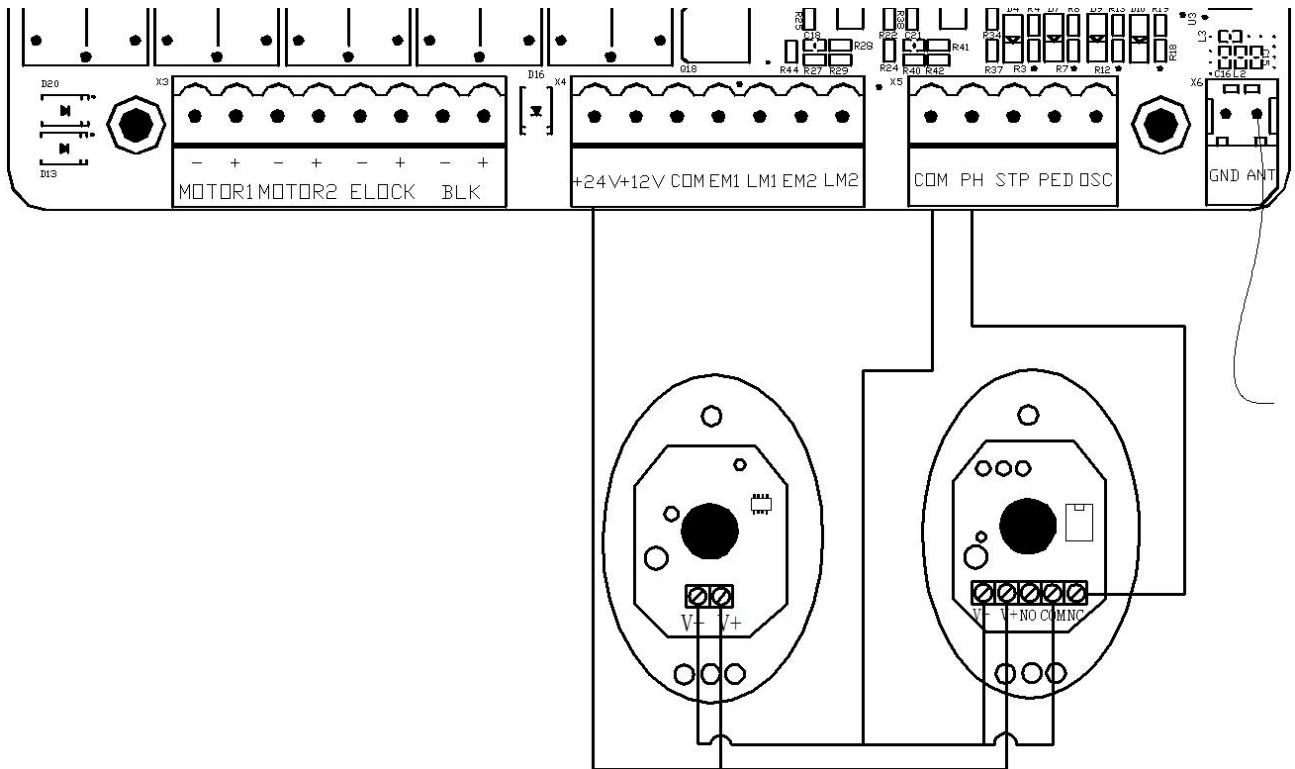
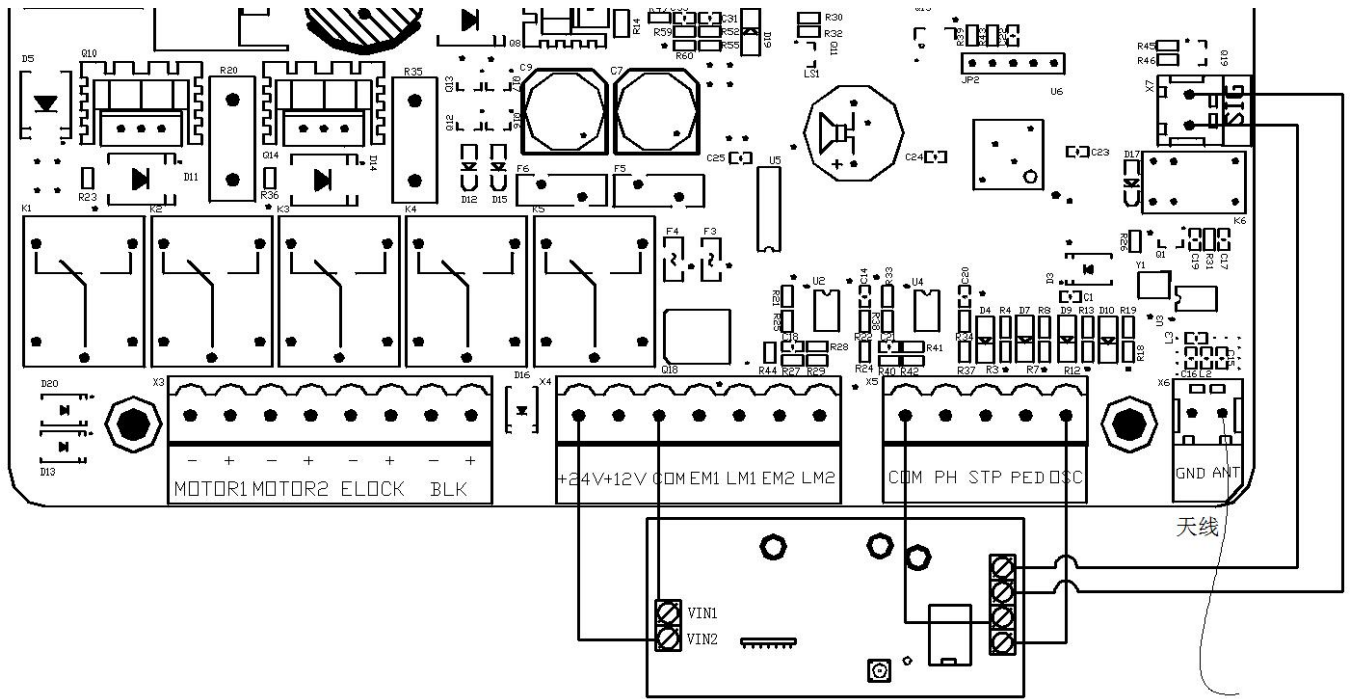

Figure 13

WIFI Module Wiring Instructions



WIFI Module (24VDC)

Figure 14

9.3 Digital Screen Setting

When the control board is working, the users can check working state of gate opener by digital screen on the control board.

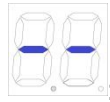

: no input;

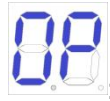

: under opening state;

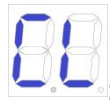

: under closing state;

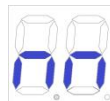

: manual mode;



: travel setting;

9.4 Travel Setting (VERY IMPORTANT)

In the first installation of gate openers, the installer need to set open and closed limit switch positions for running the travel.

9.4.1 Learn the journey in the distress limit mode

Open both sides of the gate and lock the clutch, and then press and hold the "+" button on the control board until the digital screen shows "SU". After this step, the gate will firstly run towards the closing direction and stop, and then the gate will automatically open. When the two swing gates are fully open, the gates will automatically close for the second time, and the travel setting will be completed when the gates are closed. If the distance of starting slow speed of gate is not appropriate, adjust the "SLOW DOWN" button to revise the distance.

Note:

- Wiring: the black wire of main engine 1 is connected to the left side of MOTOR1; The brown cable of host 1 connects to the right side of MOTOR1. The black cable of main engine 2 connects to the left side of MOTOR2; The brown cable of main engine 2 connects to the right side of MOTOR2.
- In single-door mode, the host connects to MOTOR1.
- If the gate suddenly stops during travel setting, please increase the resistance force.
- If the gate didn't stop when meets the obstacles during travel setting, please appropriately reduce the resistance force.
- Installer must redo travel setting after modifying the "SPEED" trimmer.

9.5 Trimmers Setting

Obstacle Sensibility Trimmer

To adjust the sensitivity of obstacle -- clockwise to increase, counterclockwise to reduce the sensitivity of obstacle. If there are environmental effects, such as heavy winds, adjust the trimmer according to environment.

Slow Speed Distance Trimmer

To adjust slow speed distance -- clockwise to increase, counterclockwise to decrease slow speed distance. Please do not set very short slow speed distance, to avoid the gate collision.

Gate Moving Speed Trimmer

To adjust gate moving speed -- clockwise to accelerate, counterclockwise to slow down. The trimmer can be adjusted to change the opening and closing travel time. This adjustment must be finished before travel setting.

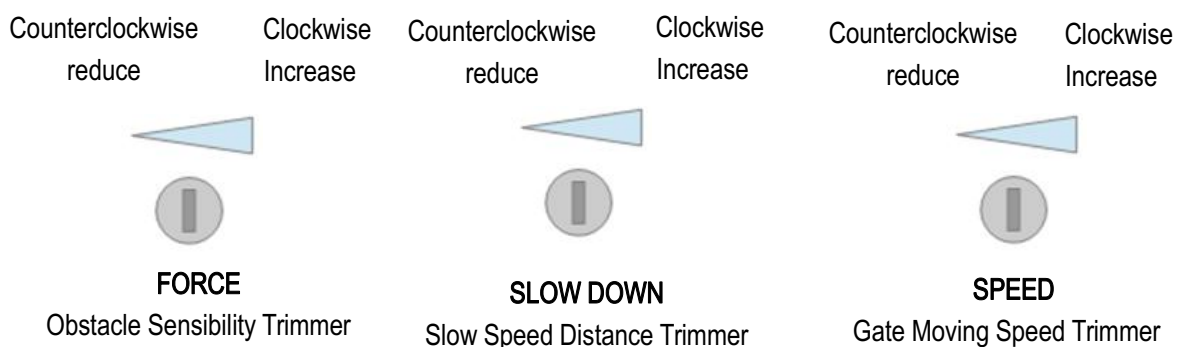

Figure 15

9.6 Learning Remote Control & Delete Remote Control

9.6.1 Learning Remote Control

Press and hold "-" button, the alarm light will keep flashing, and digital screen displays remote control mode -- "PO" -- two swing gates single channel mode; "Pd" -- single gate four channel mode; Press the button of the remote control to be learned, the digital screen will show the number of current learned remote control, then the remote control learning is completed. (The default of new paired remote control is two swing gates single channel mode).

9.6.2 Delete Remote Control

Enter into "AE" in the digital screen and then to choose "rE" to delete the remote controls.

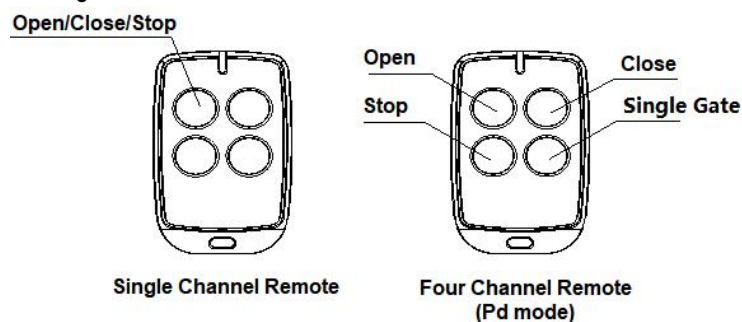

Figure 16

9.6.3 Special Remote Control Key-button

Press and hold the combination keys for 5S.

C(stop)+D(single gate) combination key -- enter into remote control learning.

9.7 Control Board Settings

9.7.1 Base Menu

Press "PROG" to enter into base menu;

Digital screen shows "NE", select other functions of this menu by "+" and "-" buttons.

Press "SET" to confirm or to enter into sub-menu.





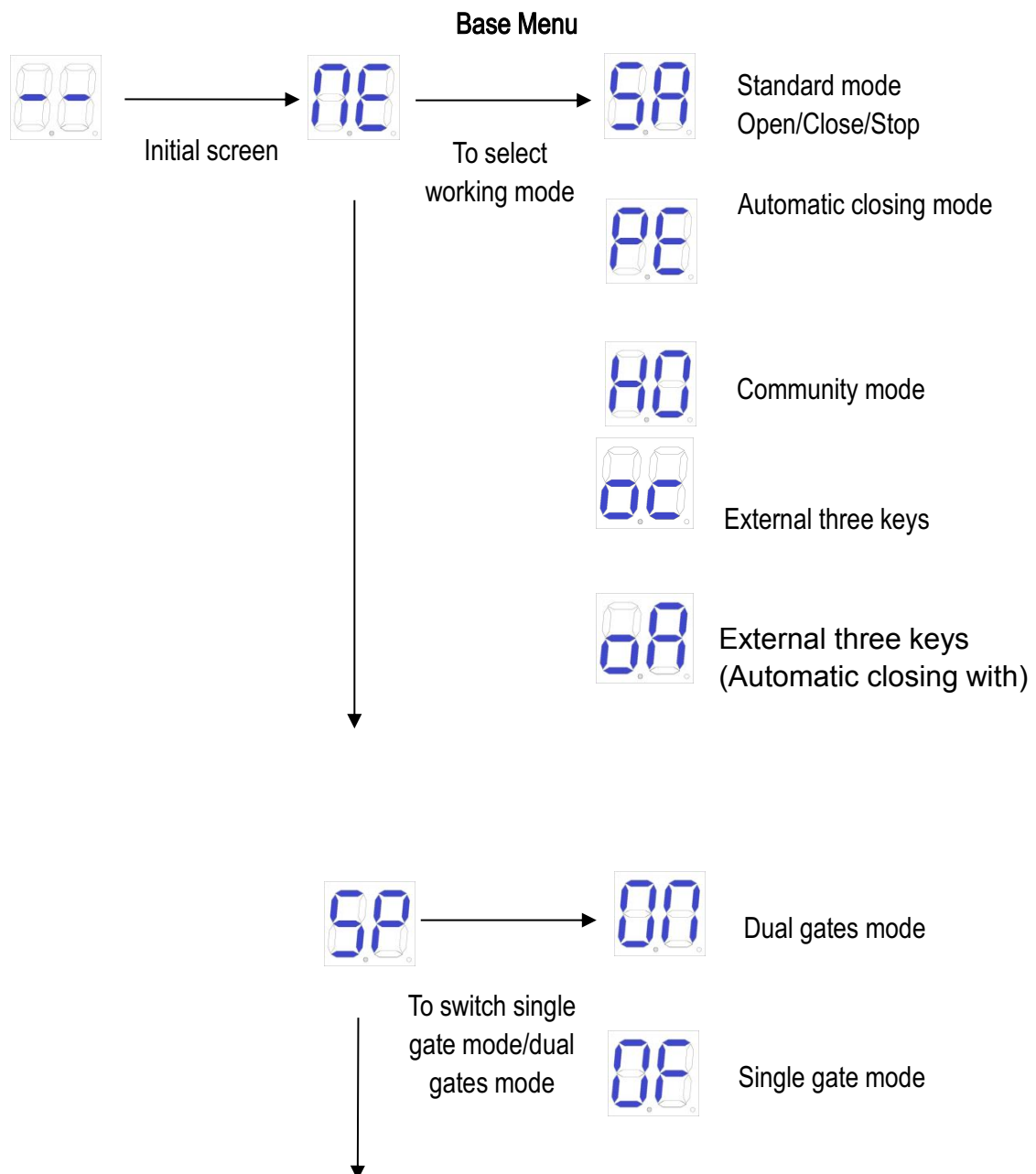

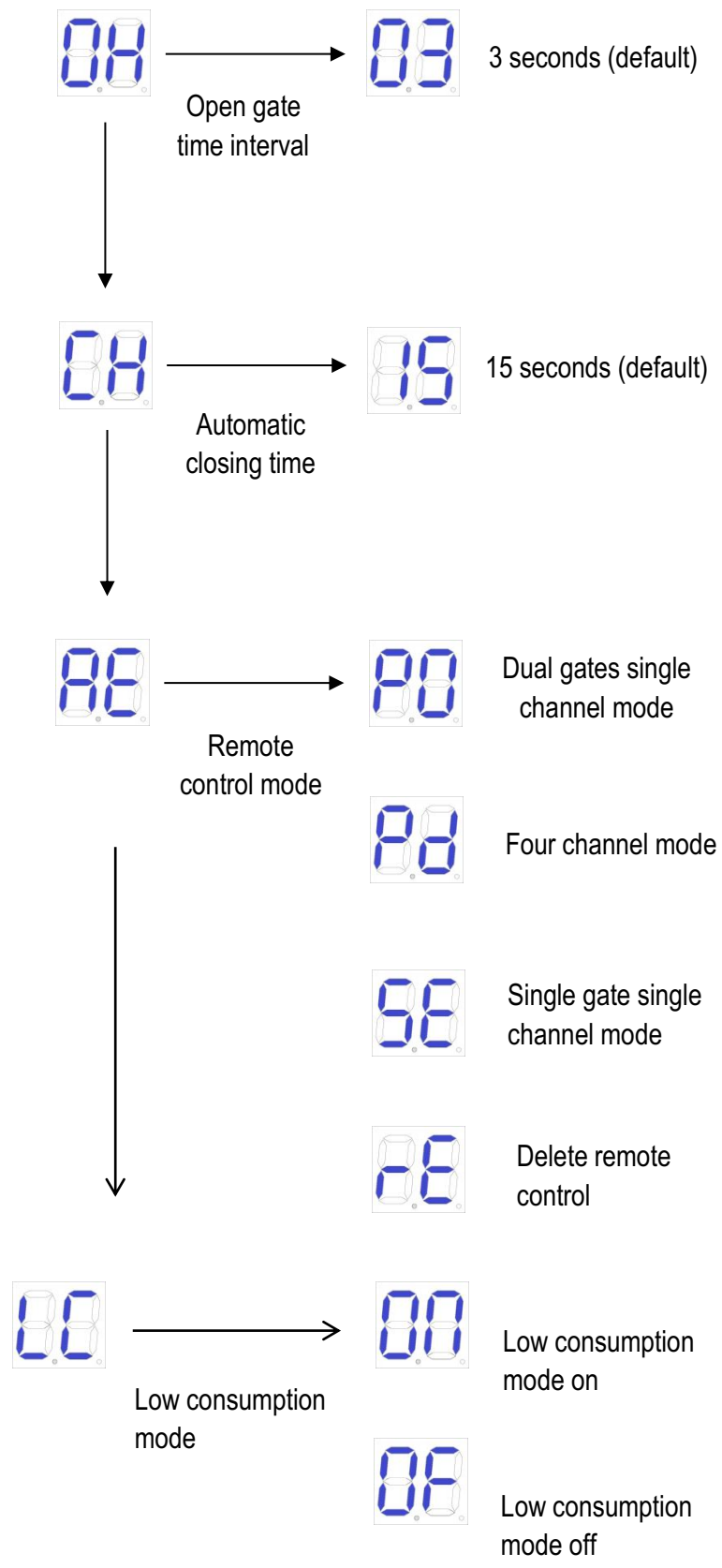
To exit menu, press "PROG".









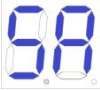

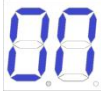
If no command for one minute, the menu will automatically exit.

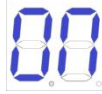
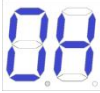

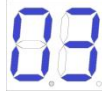
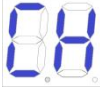

9.7.2 Base Menu Instruction

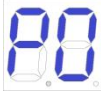
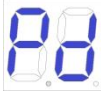
Menu Press "PROG" to enter into base menu.	Option Press "+"(up) or "-"(down) to select; Press "SET" to confirm.	Default/Attention
<div style="text-align: center;">  <p>Working Mode</p> </div>	<div style="text-align: center;">  <p>Standard mode; O/C/S (Open/Close/Stop).</p> </div> <div style="text-align: center;">  <p>O/S/C standard mode with automatic closing function. When the gate opens, it will automatically close after automatic closing time. If a "close the gate" command is sent during the automatic closing time waiting time, the automatic closing function will be canceled.</p> </div> <div style="text-align: center;">  <p>Community mode(with automatic closing function). When the gate opens, any gate command will not be responded until it closes automatically. If user sends gate command during the closing process, then the gate will reopen. If a gate command is sent during the automatic closing waiting time, this waiting time will be recalculated. If the gate is not closed completely for more than ten consecutive times, the automatic closing function will be canceled and the gate will be closed by re-sending the gate closing command. Note that in community mode, the gate still has the automatic closing function in case of meeting obstacles.</p> </div> <div style="text-align: center;">  <p>External three keys (open/close/stop)</p> </div> <div style="text-align: center;">  <p>External three keys o/p/s (Automatic closing with)</p> </div>	<div style="text-align: center;">  <p>Standard mode; O/C/S (Open/Close/Stop).</p> </div>

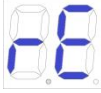
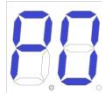
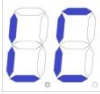
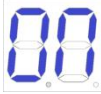
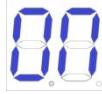
 <p>Single Gate/Dual Gates Switch</p>	 Dual gates mode(default).  Single gate mode.	 Dual gates mode.
 <p>Open Gate Time Interval</p>	 00-10: Open gate time interval is 0-10 seconds(default 3 seconds). If the interval shorter than 2 seconds, then the electric lock cannot be used.	 3 seconds.
 <p>Automatic Closing Time</p>	 Automatic closing time can be set as 15(default), 30, 60, 90 seconds.	 15 seconds.
 <p>Remote Control Mode</p>	 Dual gates single channel mode.  Four channel mode.  Single gate single channel mode.  Delete all paired remote controls	 Dual gates single channel mode.
 <p>Low consumption mode</p>	 Low consumption mode on (When there is no operation in the initial screen, the control board will automatically enter the low-consumption mode after 1 minute.)	 Low consumption mode on

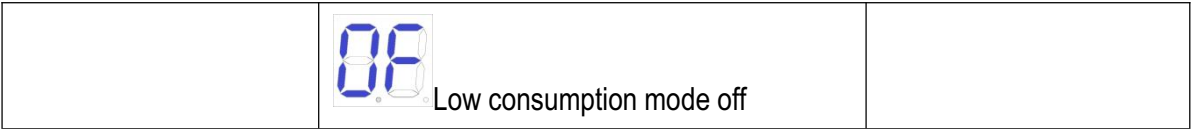

9.7.3 Advanced Menu Instruction

Long press "PROG" 2 seconds to enter into advanced menu.
 Digital Screen shows "TL", press "+"(up) or "-"(down) to select;
 Short press "SET" to confirm or to enter into sub-menu.
 Short press "PROG" to exit.
 If no command for one minute, the menu will automatically exit.

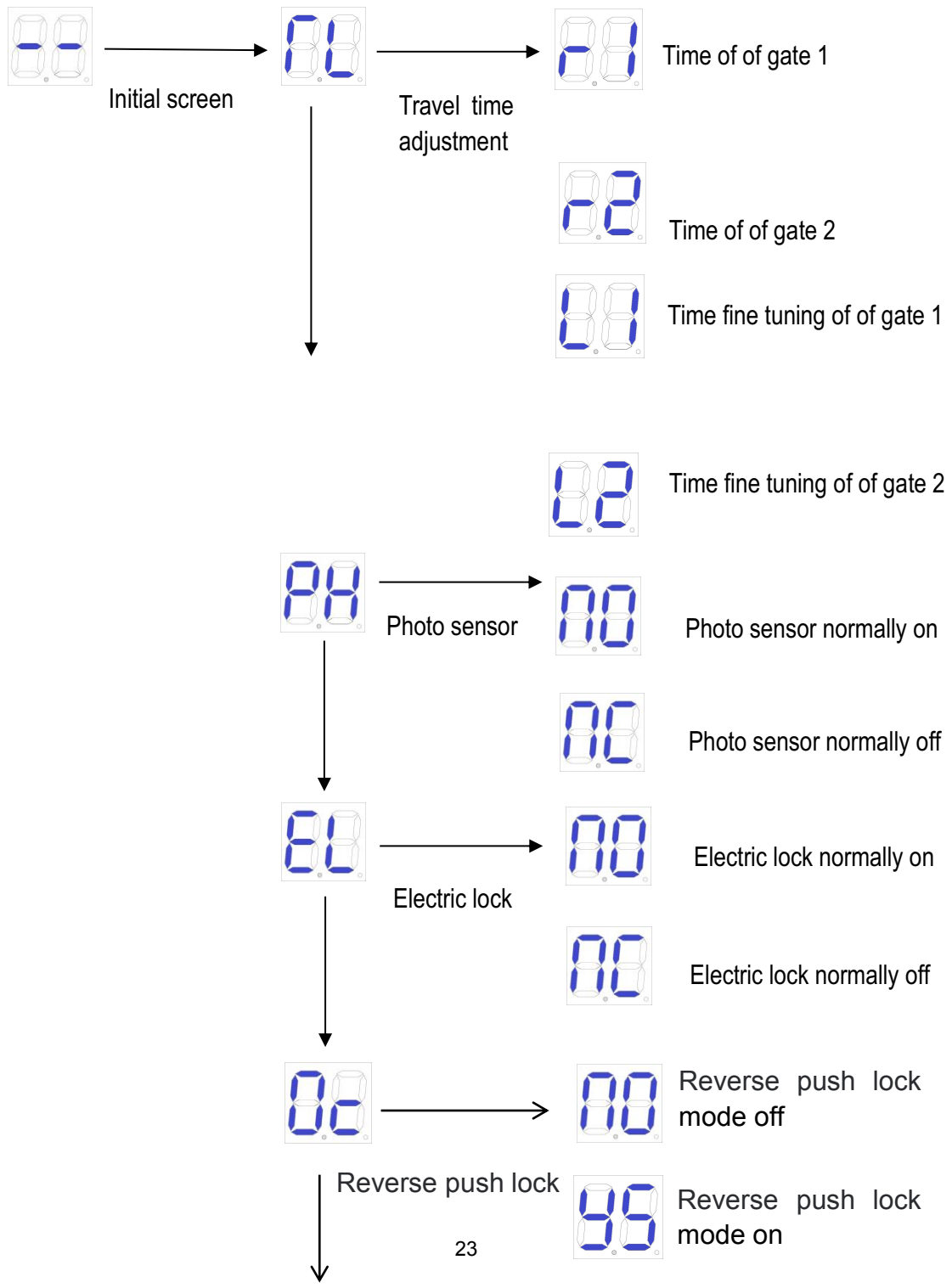

Advanced Menu

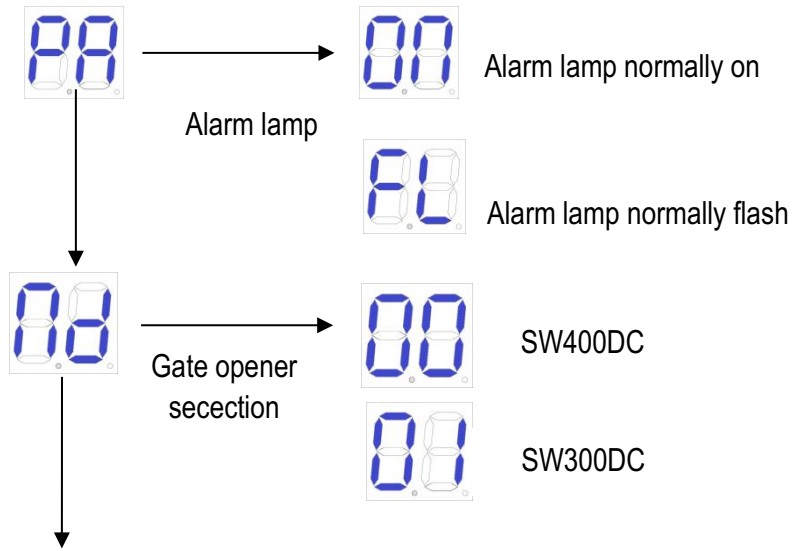

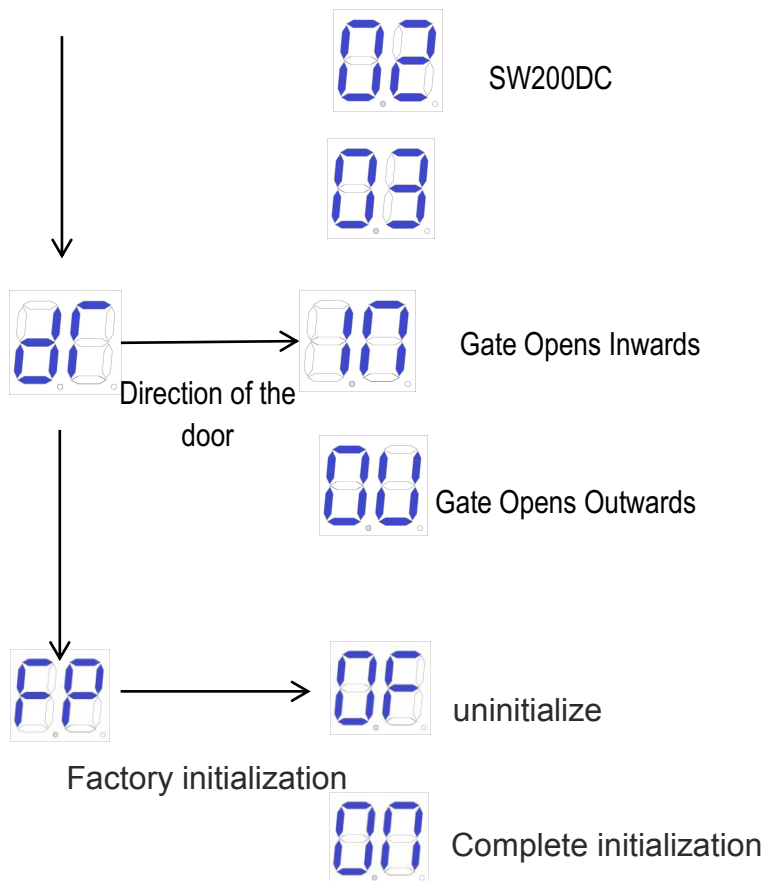



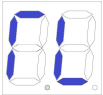
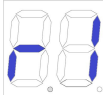

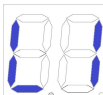
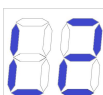

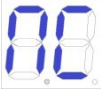

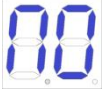

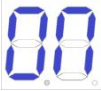
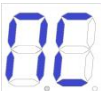
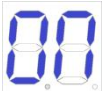





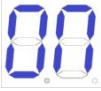
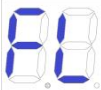
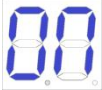
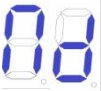
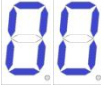
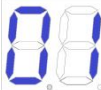
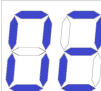

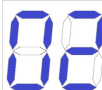
9.7.4 Advanced Menu Instruction

Menu Long press "PROG" 2 seconds to enter into base menu.	Option Press "+"(up) or "-"(down) to select; Press "SET" to confirm.	Default/Attention
 <p>Travel time adjustment</p>	 Time of of gate1  Time of of gate2  Time fine tuning of of gate 1  Time fine tuning of of gate 2	<p>After automatic learning, if the stroke is not ideal, it can be adjusted manually. The shorter the time under the resistance limit, the farther the deceleration distance of the door. And in the Hall limit, the shorter the time, the shorter the door travel.</p>

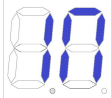
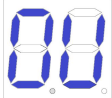
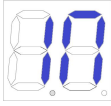
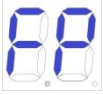
 <p>Photo Sensor</p>	 N/C; photo sensor normally is on. (Default)  N/O; photo sensor normally off.	 N/O; photo sensor normally on.
 <p>Electric Lock</p>	 Electric lock normally is on. (Default)  Electric lock normally is off.	 Electric lock normally on.
 <p>Reverse push lock</p>	 Reverse push lock mode off  Reverse push lock mode on  (When the electric lock is started, M1 will run for a distance in the direction of the door to prevent the electric lock from getting stuck and unable to be opened.)	 <p>Reverse push lock mode off</p>
 <p>Alarm Lamp</p>	 Alarm lamp normally is on. 24V power supply. (Default)  Alarm lamp normally flashes. 24V power supply.	 Alarm lamp normally is on. 24V power supply.
 <p>Gate Opener Seccion</p>	 SW400DC.  SW300DC.  SW200DC. (Default)  PK300DC	 SW200DC.

 <p>Direction of the door</p>	 Gate Opens Inwards (Default)  Gate Opens Outwards	 Gate Opens Inwards
 <p>Factory Default Setting</p>	 Cancel factory default setting.  Factory default setting completes.	

10. Others

10.1 Maintenance

Check whether the gate operates normally every month.



For the sake of safety, each gate is suggested to be equipped with infrared protector, and regular inspection is required as well.



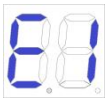

Before installation and operation of the gate opener, please read all instructions carefully.

We reserve the right to change the instruction without prior notice.

10.2 Error Message

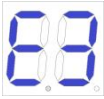
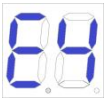
Errors that may occur when the door is operating properly

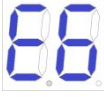
Wrong Indication	Cause of Error	Solution
	Door 1 Obstructed in opening	<ol style="list-style-type: none"> 1. Check whether there are obstacles when opening door 1 2. Adjust resistance sensitivity appropriately 3. Increase deceleration distance appropriately
	Door 2 Obstructed in opening	<ol style="list-style-type: none"> 1. Check whether there are obstacles when opening door 2 2. Adjust resistance sensitivity appropriately 3. Increase deceleration distance appropriately

	<p>Door 2 is closing with difficulty</p>	<ol style="list-style-type: none"> 1. Check whether there are obstacles when door 1 is closed 2. Adjust resistance sensitivity appropriately 3. Increase deceleration distance appropriately
	<p>Door 2 is closing with difficulty</p>	<ol style="list-style-type: none"> 1. Check whether there are obstacles when door 2 is closed 2. Adjust resistance sensitivity appropriately 3. Increase deceleration distance appropriately
	<p>Infrared disconnect</p>	<ol style="list-style-type: none"> 1. Check the infrared setting status 2. Whether there are occlusions in the infrared
	<p>Door 1 closes before door 2</p>	<ol style="list-style-type: none"> 1. Relearn your itinerary 2. Adjust the opening time interval
	<p>The motor works for too long</p>	<ol style="list-style-type: none"> 1. Check whether you have completed the itinerary 2. Hall component damage
	<p>No study itinerary</p>	<p>Re-complete the trip</p>

10.3 Troubleshooting

Problems	Possible Reasons	Solutions
The gate cannot open or close normally, and Display does not light.	<ol style="list-style-type: none"> 1.The power is off. 2.Fuse is burned. 3.Control board power wiring with problem. 	<ol style="list-style-type: none"> 1.Switch on the power supply. 2.Check the fuse, change the fuse if burnt. 3.Re wiring according to instructions.
The gate can open but cannot close.	<ol style="list-style-type: none"> 1.Photocell wiring with problem. 2.Photocell mounting with problem. 3.Photocell is blocked by objects. 4.Sensitivity of obstacle is too high. 	<ol style="list-style-type: none"> 1.If not connect photocell, please make sure that the 5 and 6, 5 and 7 short circuit; if connect infrared sensor, please make sure the wiring is correct and the photocell is N.C. 2.Make sure that the photocell mounting position can be mutually aligned. 3.Remove the obstacle. 4.Reduce the sensitivity of obstacle.
Remote control doesn't work.	<ol style="list-style-type: none"> 1.Battery level of the remote control is low. 2.Remote control learning is not completed. 	<ol style="list-style-type: none"> 1.Change the remote control battery. 2.Re-conduct remote control learning.
Press OPEN, CLOSE button, the gate is not moving, motor has noise.	Gate moving is not smoothly.	According to the actual situation to adjust the motor or the gate.
Leakage switch tripped.	Power supply line short circuit or motor line short circuit.	Check wiring.
Remote control working distance is too short.	Signal is blocked.	Connect external receiver antenna, 1.5 meters above ground.
The gate moves to the middle position to stop or reverse.	<ol style="list-style-type: none"> 1.Motor output force is not enough. 2.Sensitivity of obstacle is too high. 3.Gate meets obstacle. 	<ol style="list-style-type: none"> 1.Check whether the transformer power is normal, if not, change the transformer. 2.Adjust the TR2. 3.Remove the obstacle.

Warranty

Warranty Ordinance

1. To repair against this warranty card and invoice during the warranty period.
 2. Warranty period: 1 year after the date of invoice.
 3. Without unauthorized dismantling, any product broken or damage due to quality problem, we'll offer the repair service for free or replace for free.
 4. The malfunction and damages caused by incorrect use or man fault is not covered by this warranty.
-

Maintenance Record

Check Date	Check Content	Maintained by

PK400DCJ(SW300DC)